

45300

LEGO and the LEGO logo are trademarks of the/son/ des marques de commerce
du/son marcas registradas de LEGO Group. ©2015 The LEGO Group. 088360.



45300

LEGO and the LEGO logo are trademarks of the/son des marques de commerce
du/son marcas registradas de LEGO Group. ©2015 The LEGO Group. 088360.



education

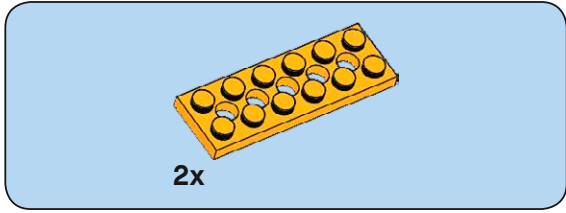

1

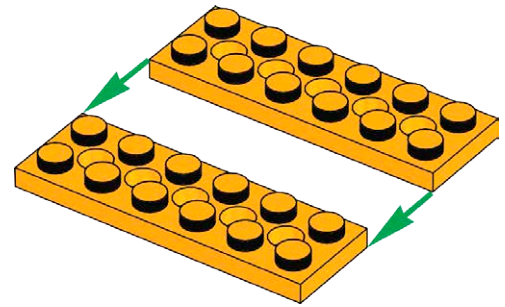

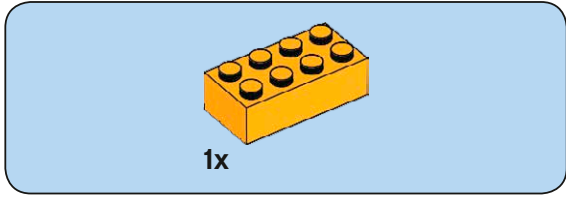

2

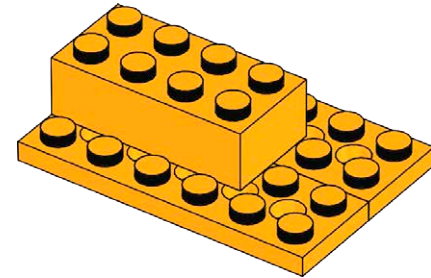

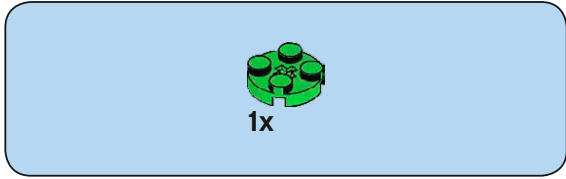

3

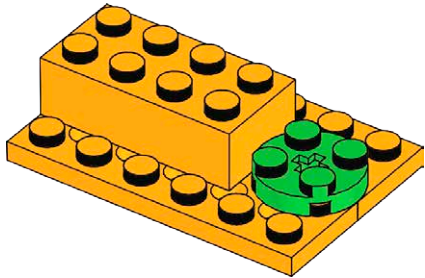

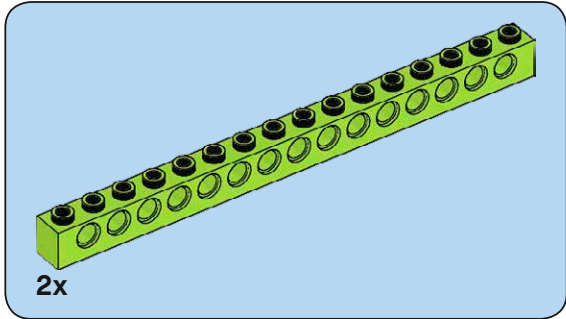

4

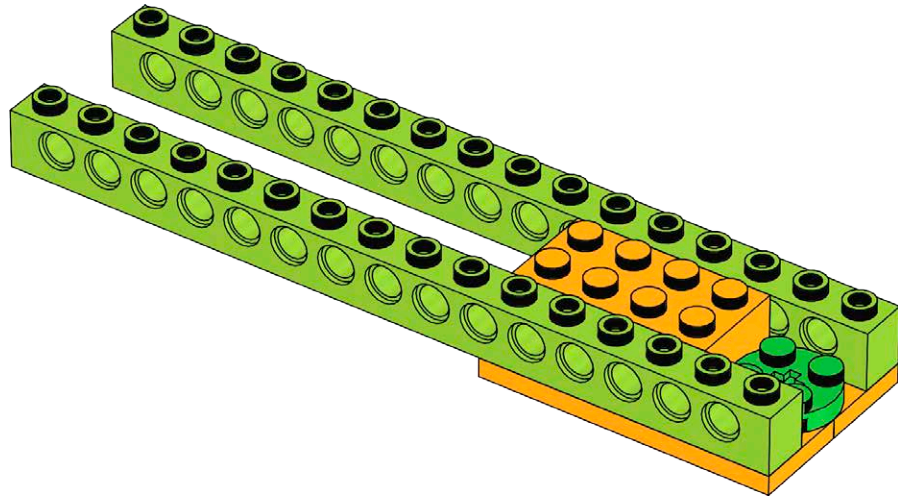

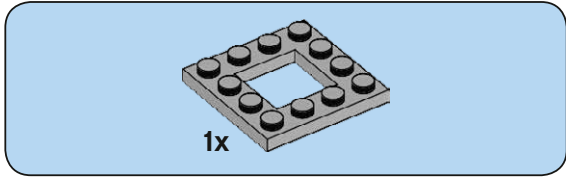

5

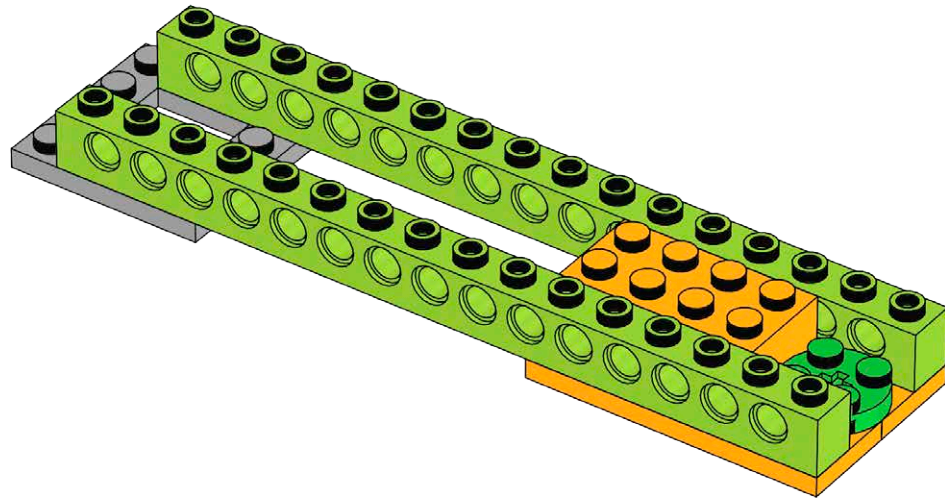

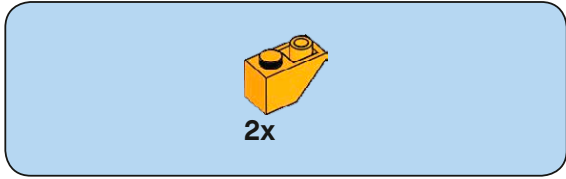

6

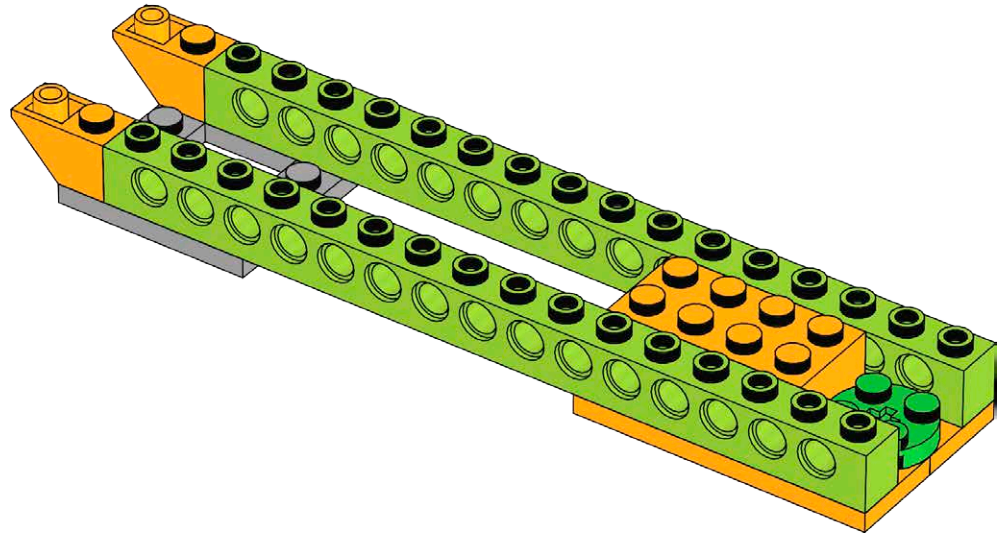

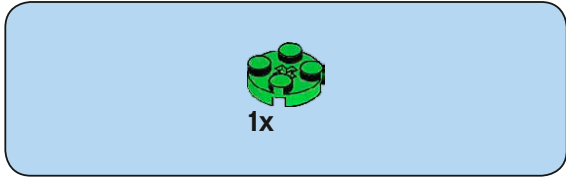

8

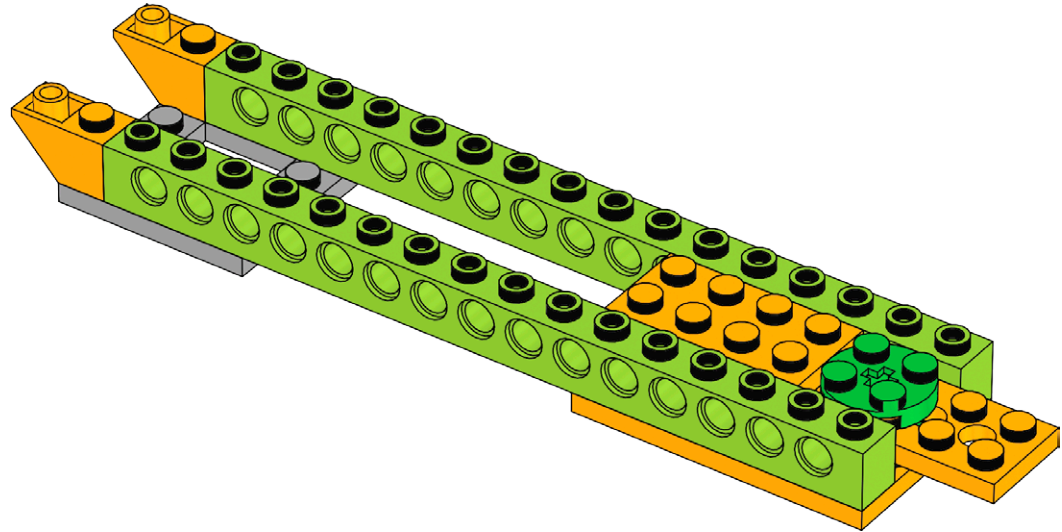

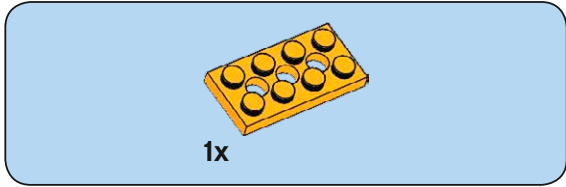

9

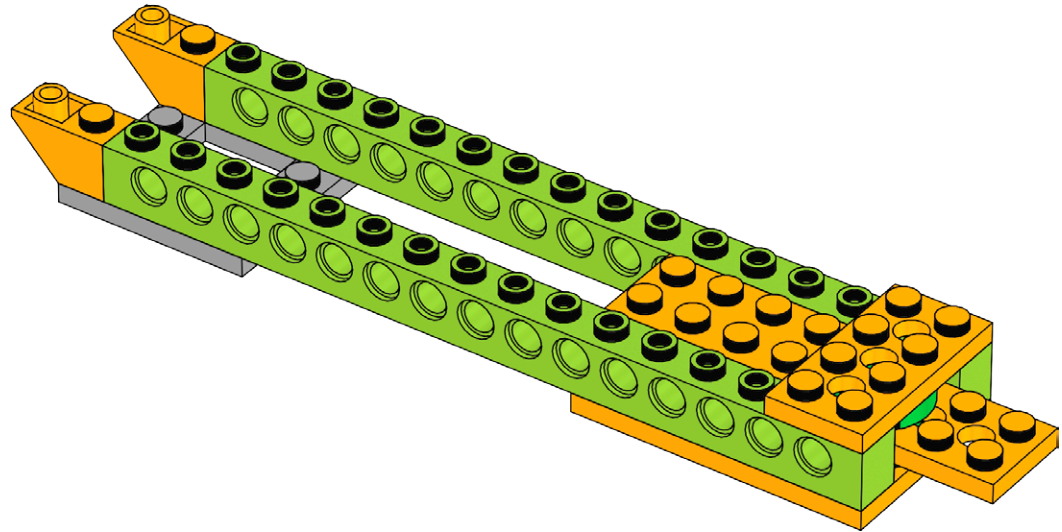

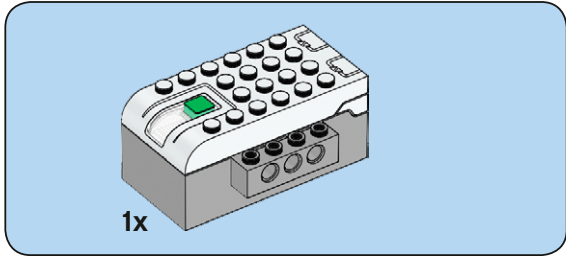

10

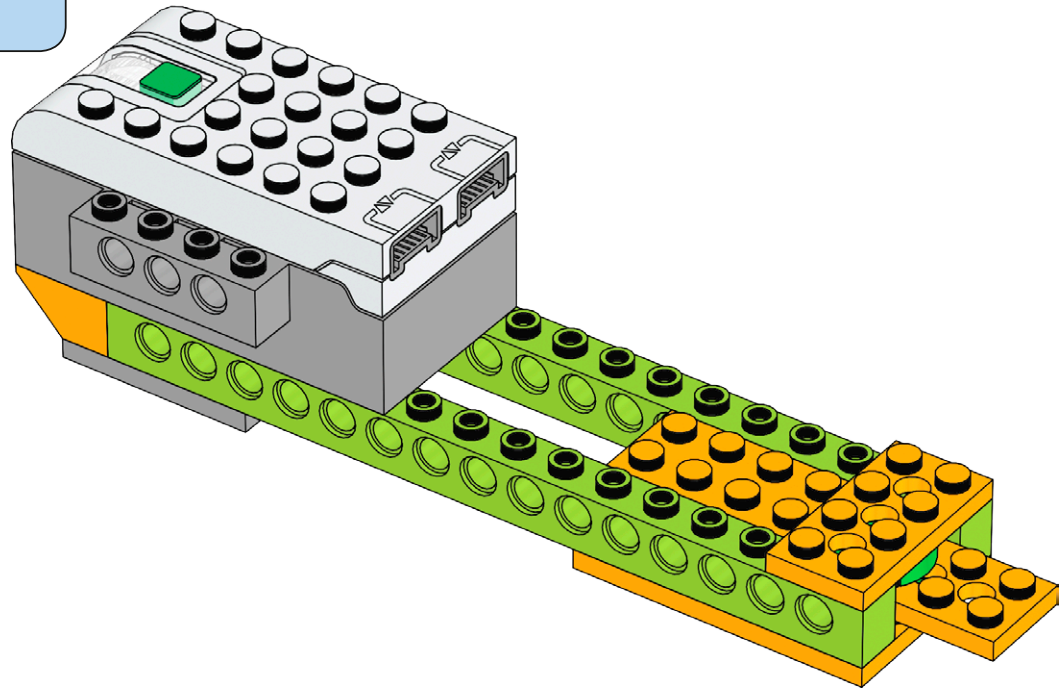

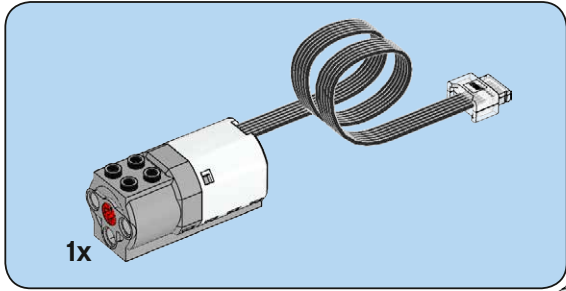

11

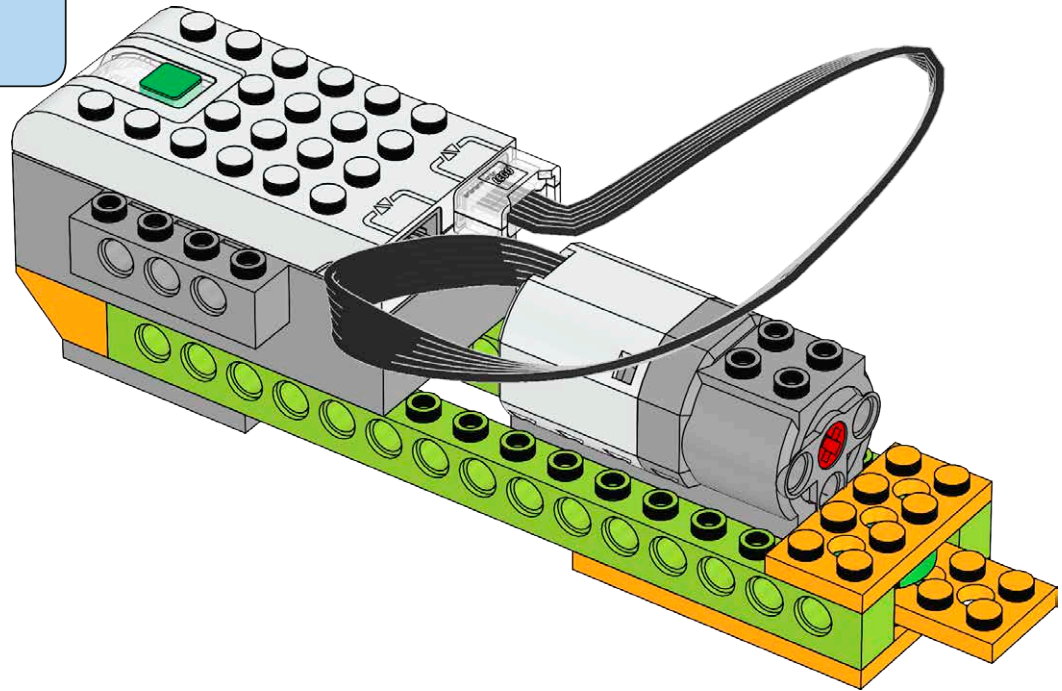

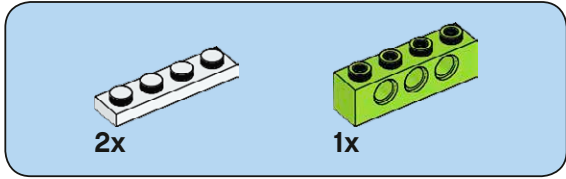

12

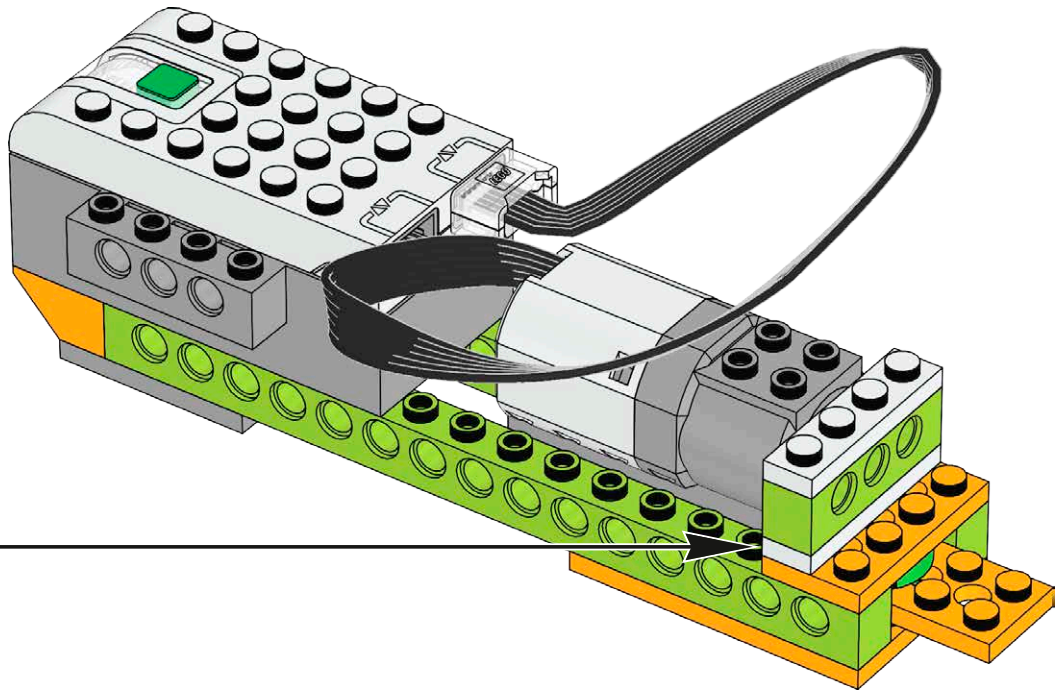
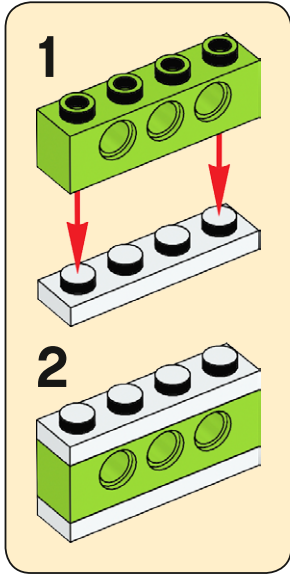

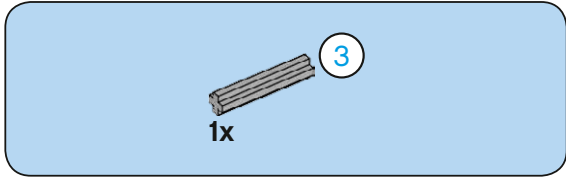

13

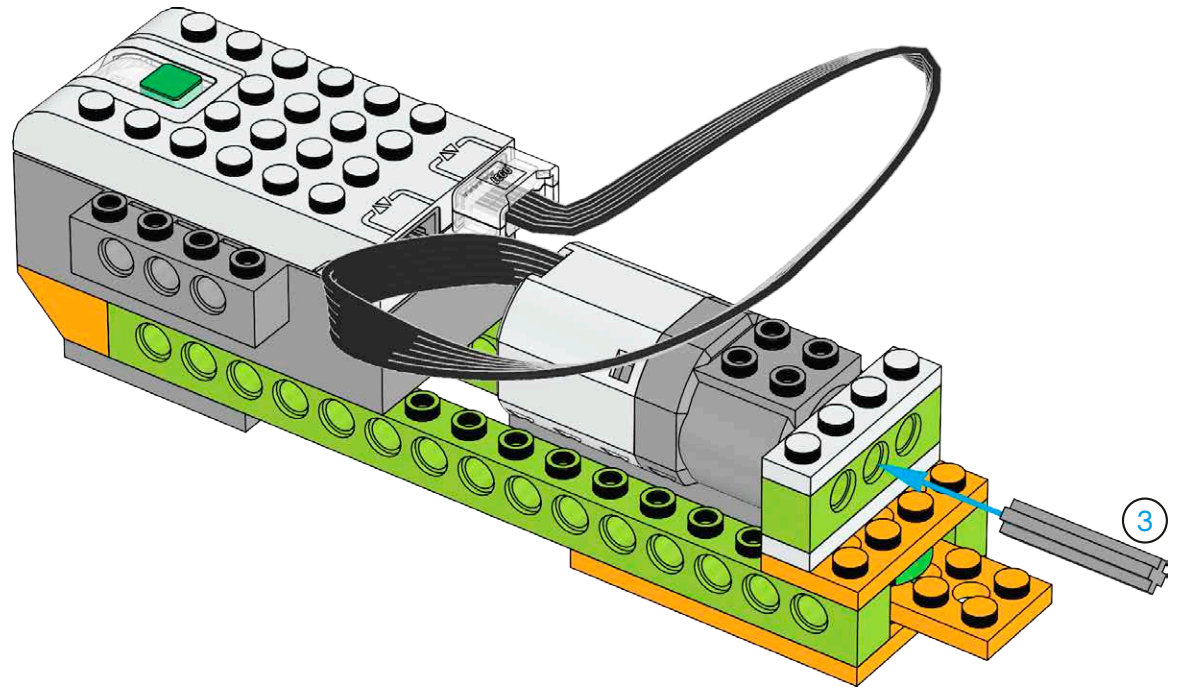

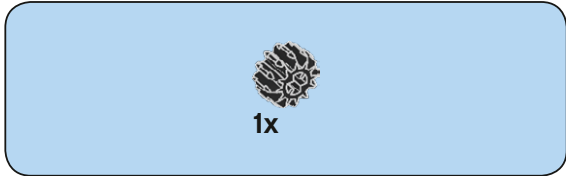

14

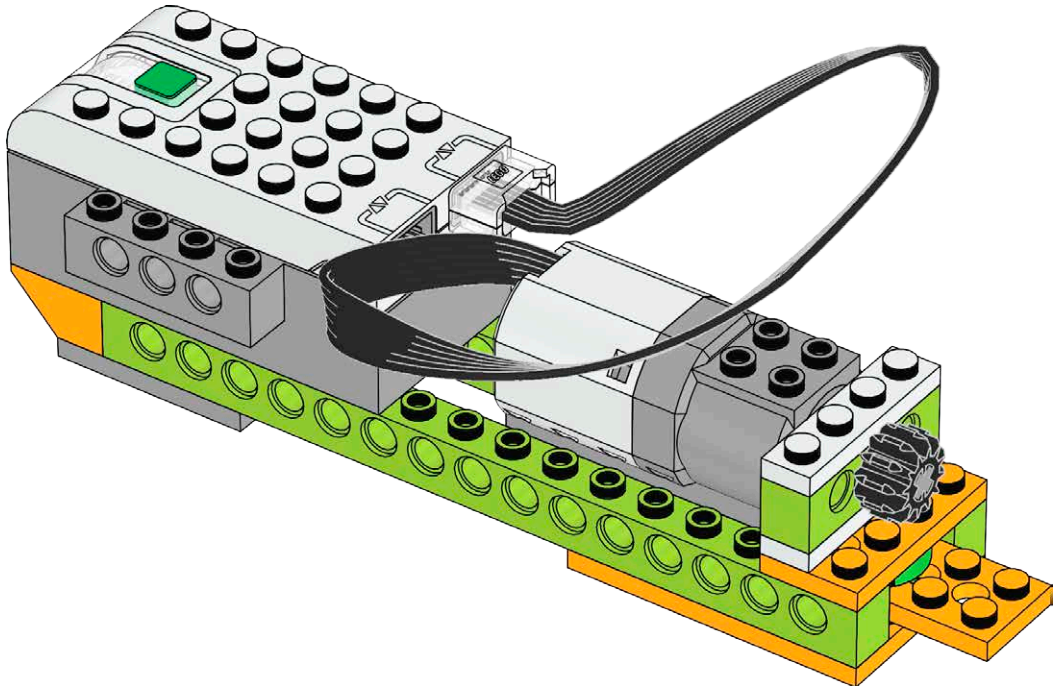

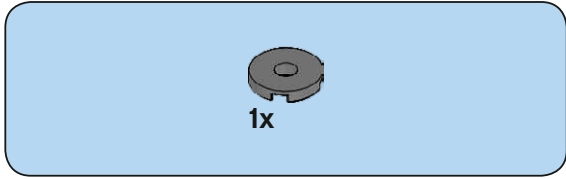

15

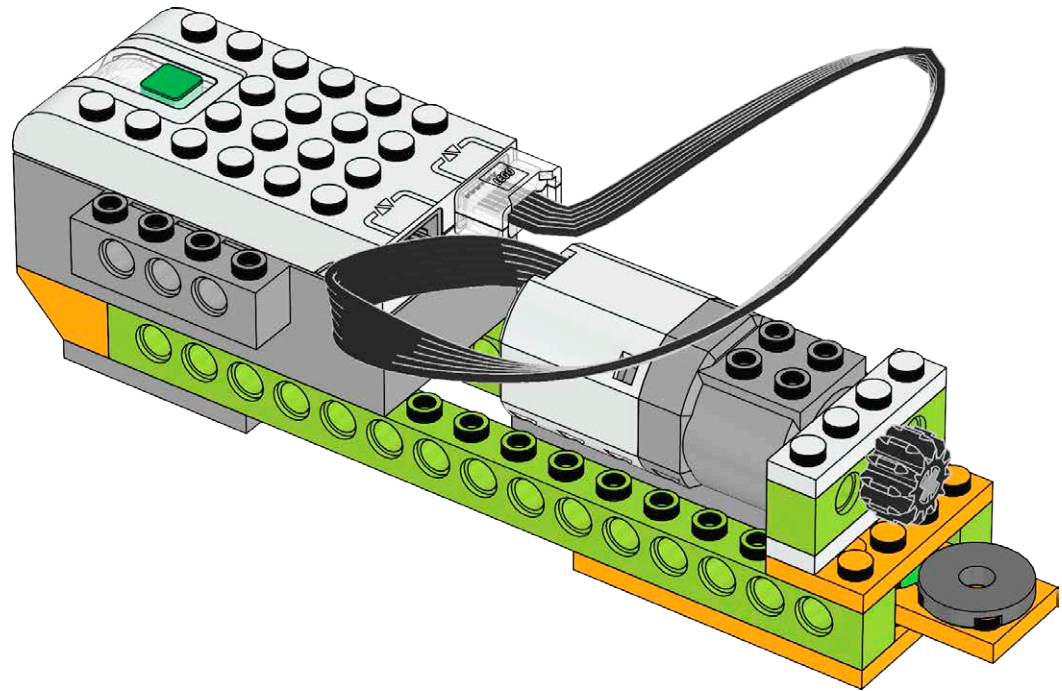

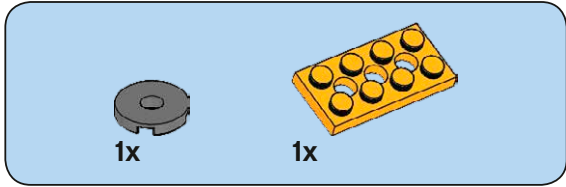

16

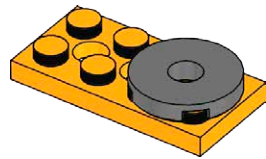

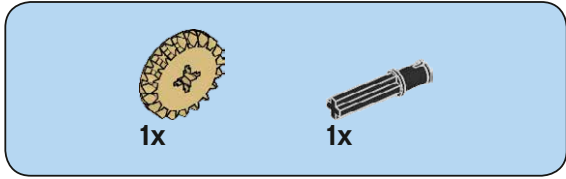

17

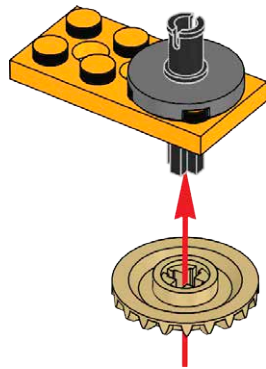

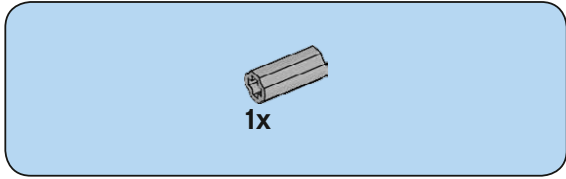

18

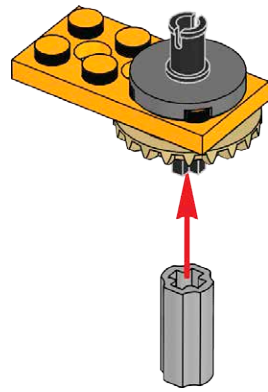

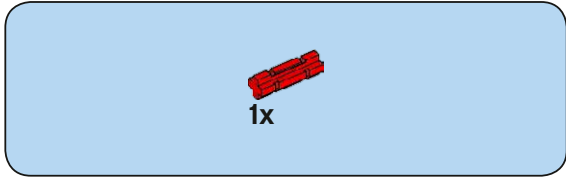

19

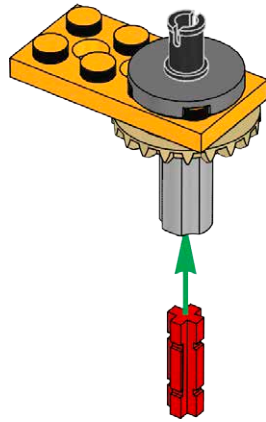

20

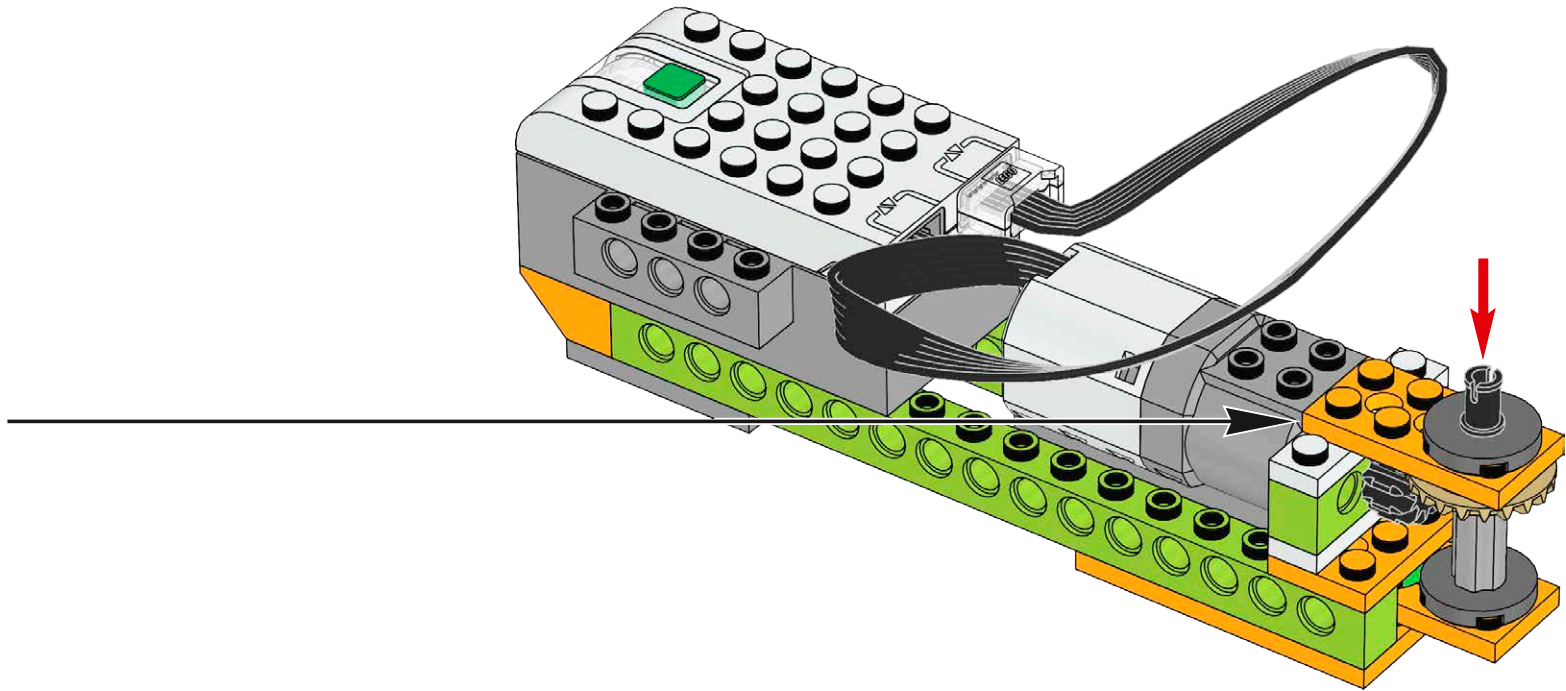

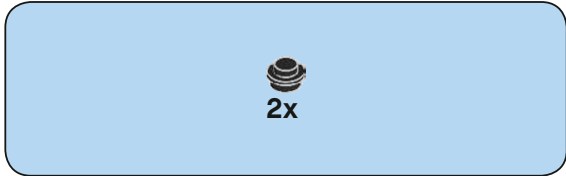

21

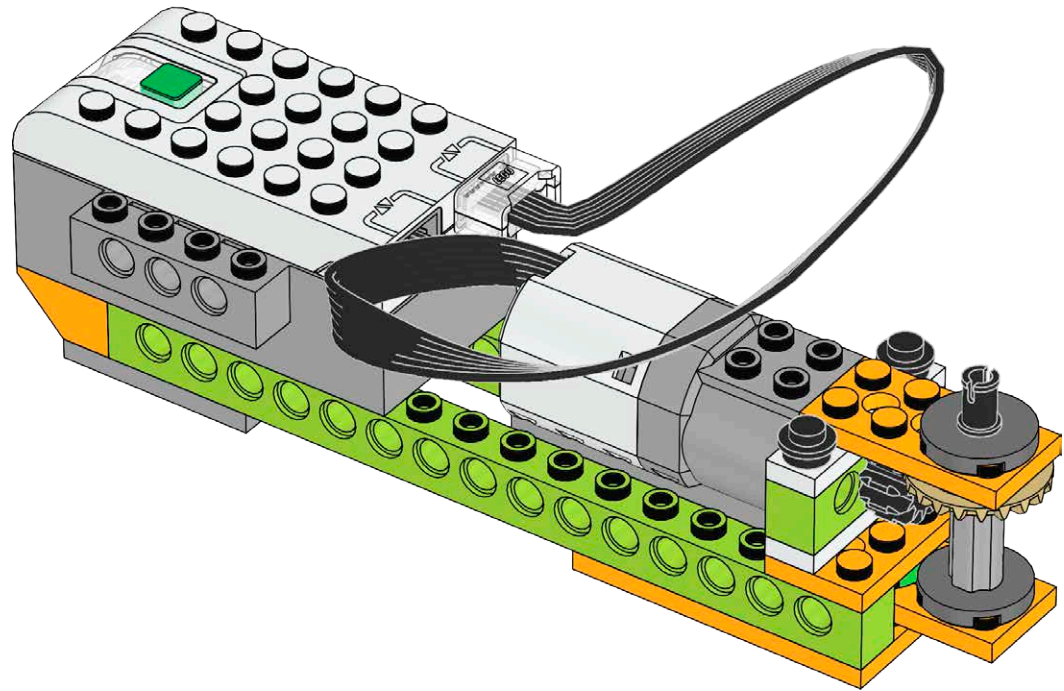

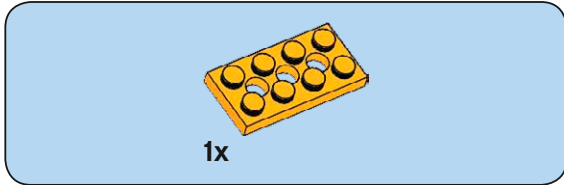

22

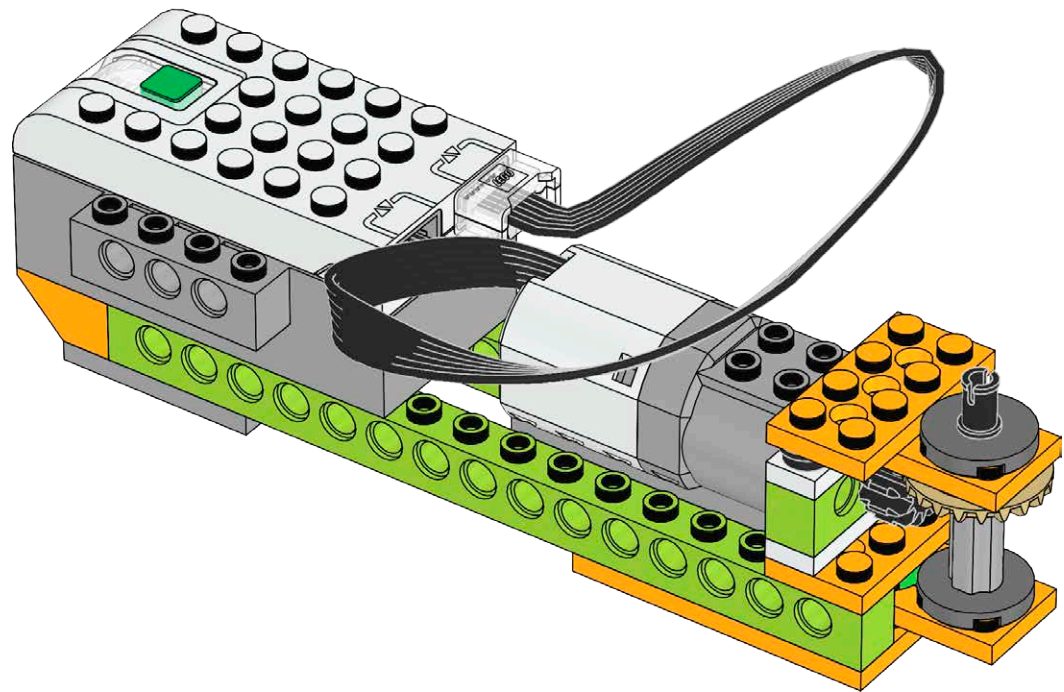

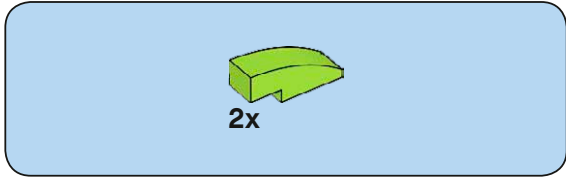

23

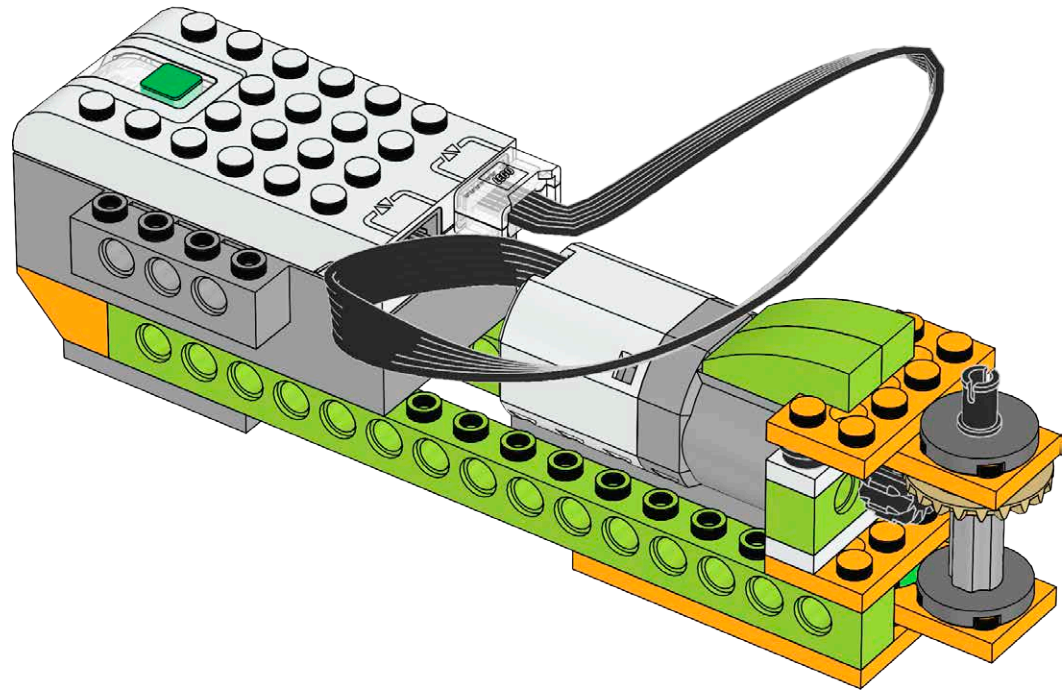

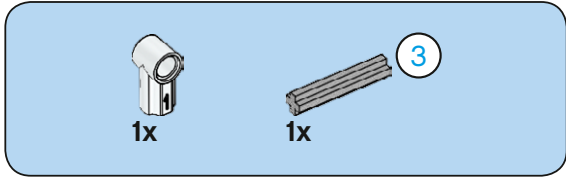

24

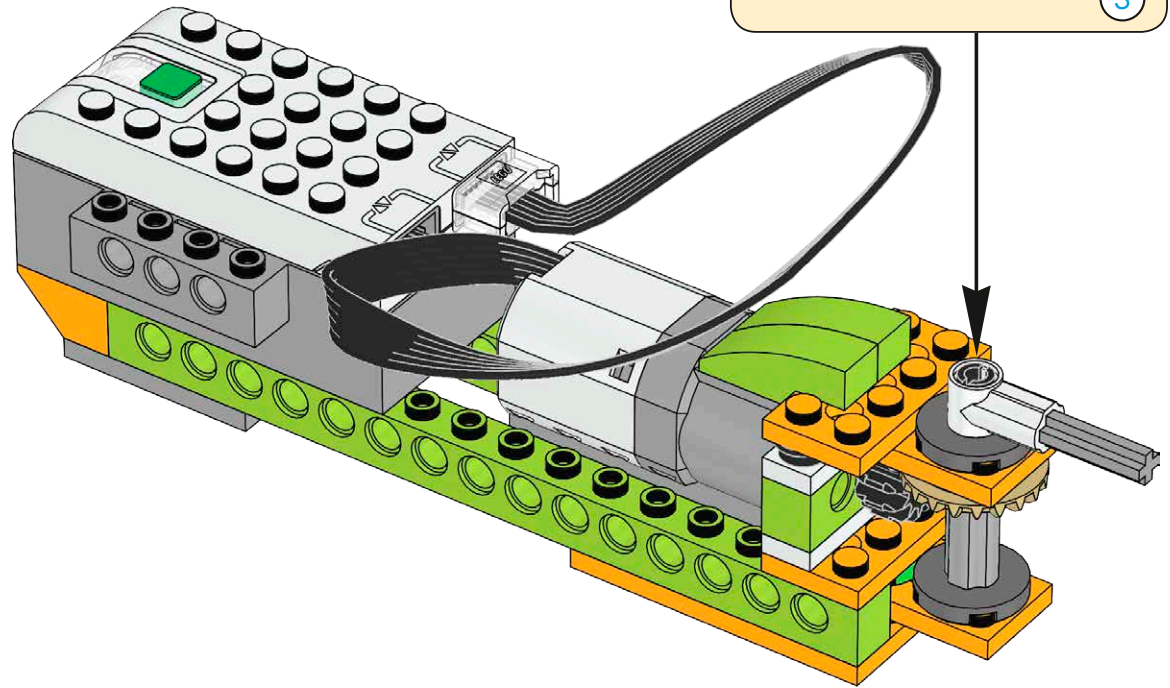
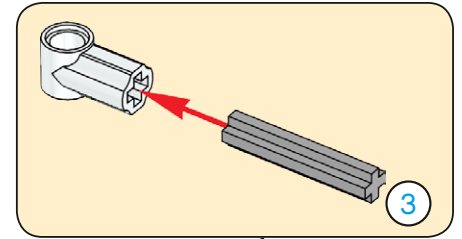

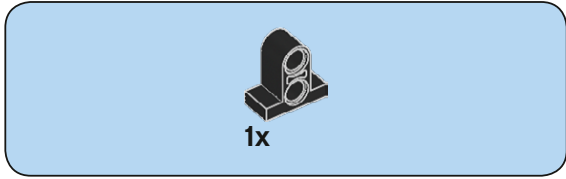

25

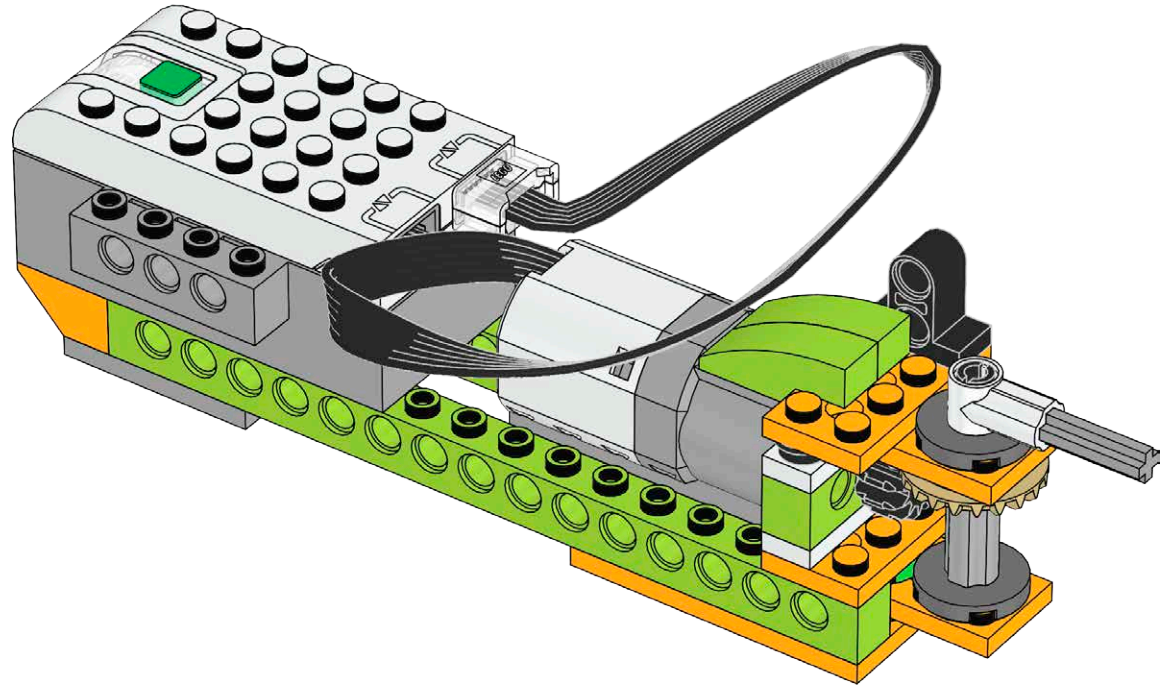

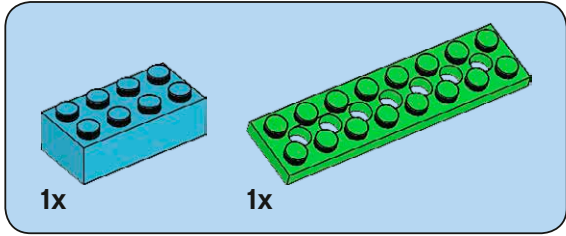

26

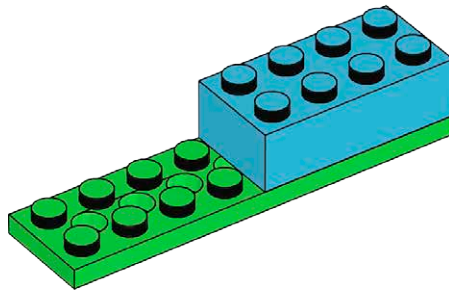

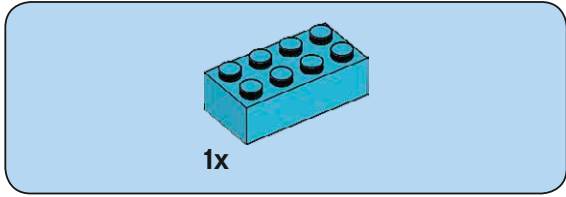

27

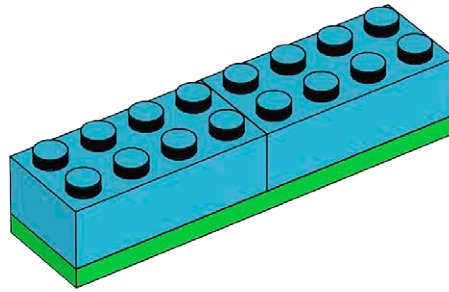

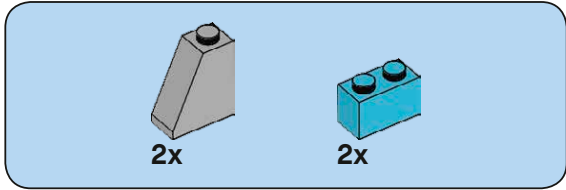

28

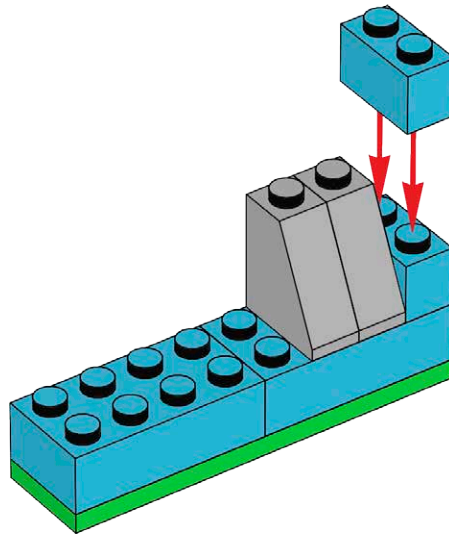

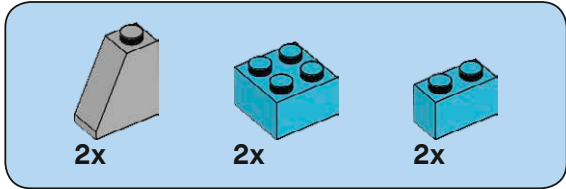

29

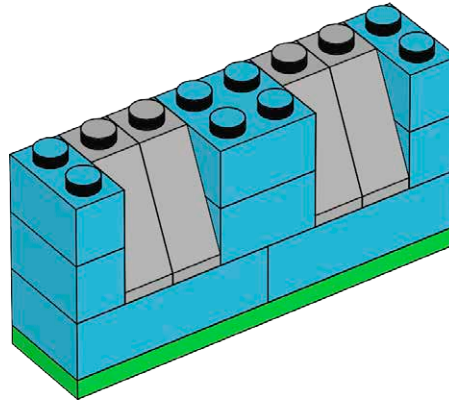

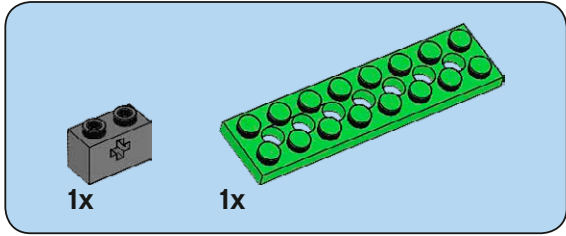

30

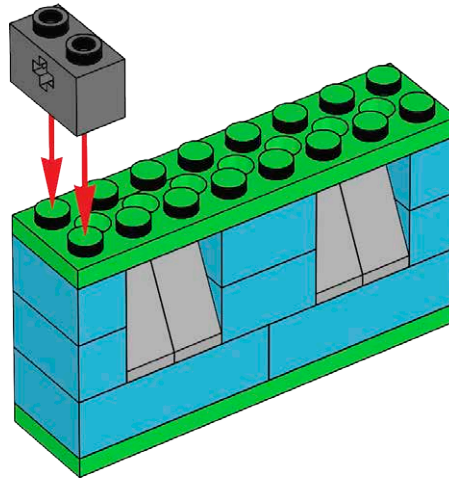

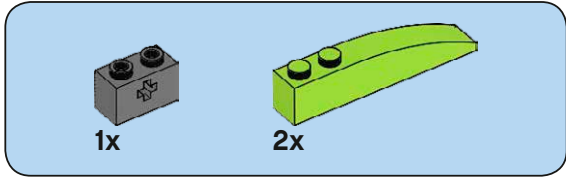

31

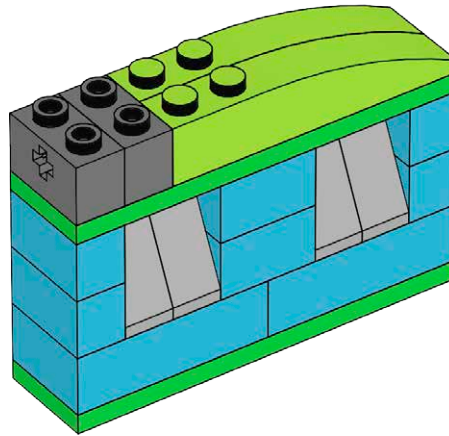

32

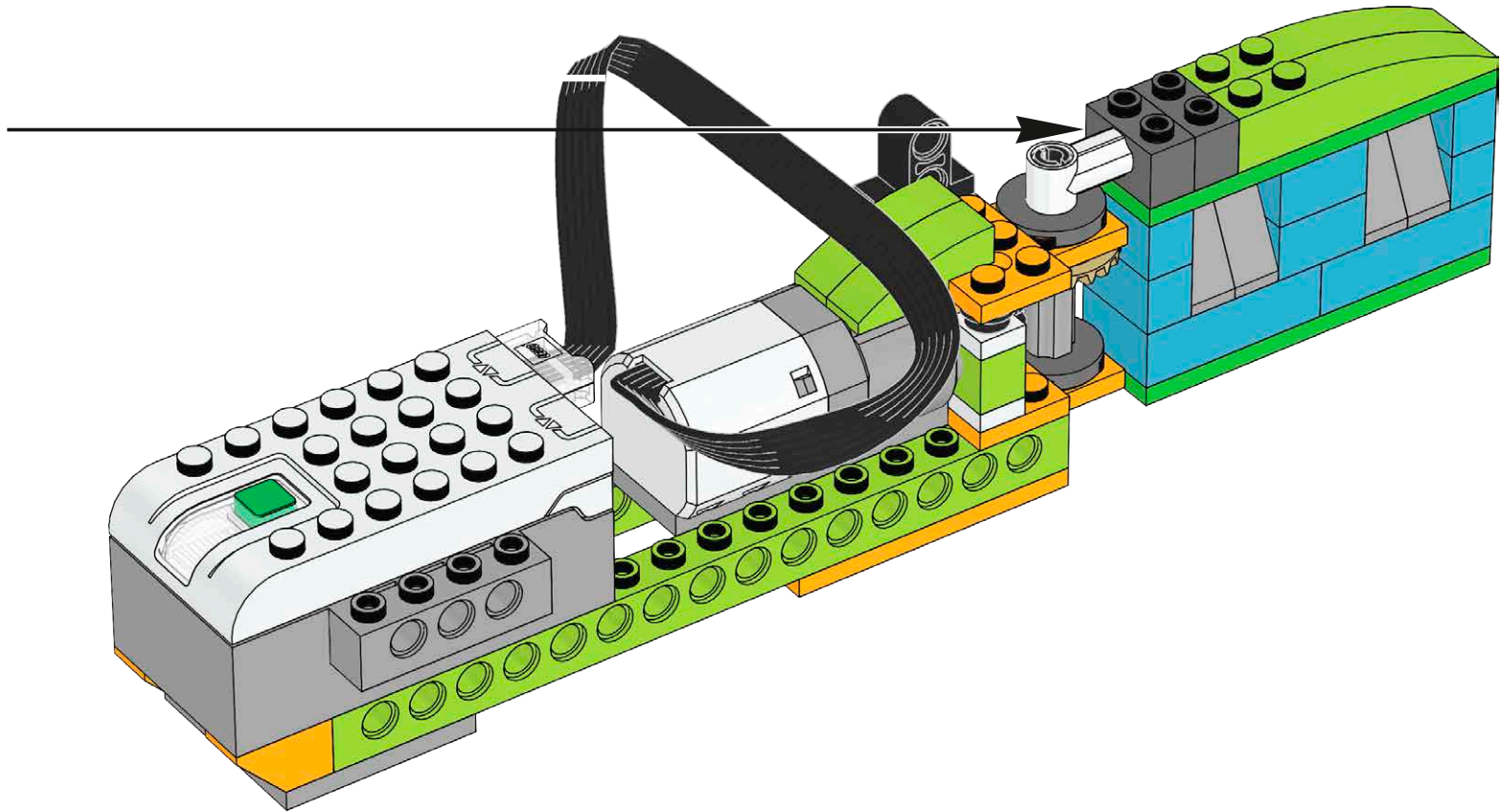

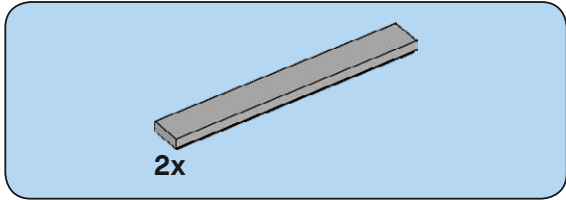

33

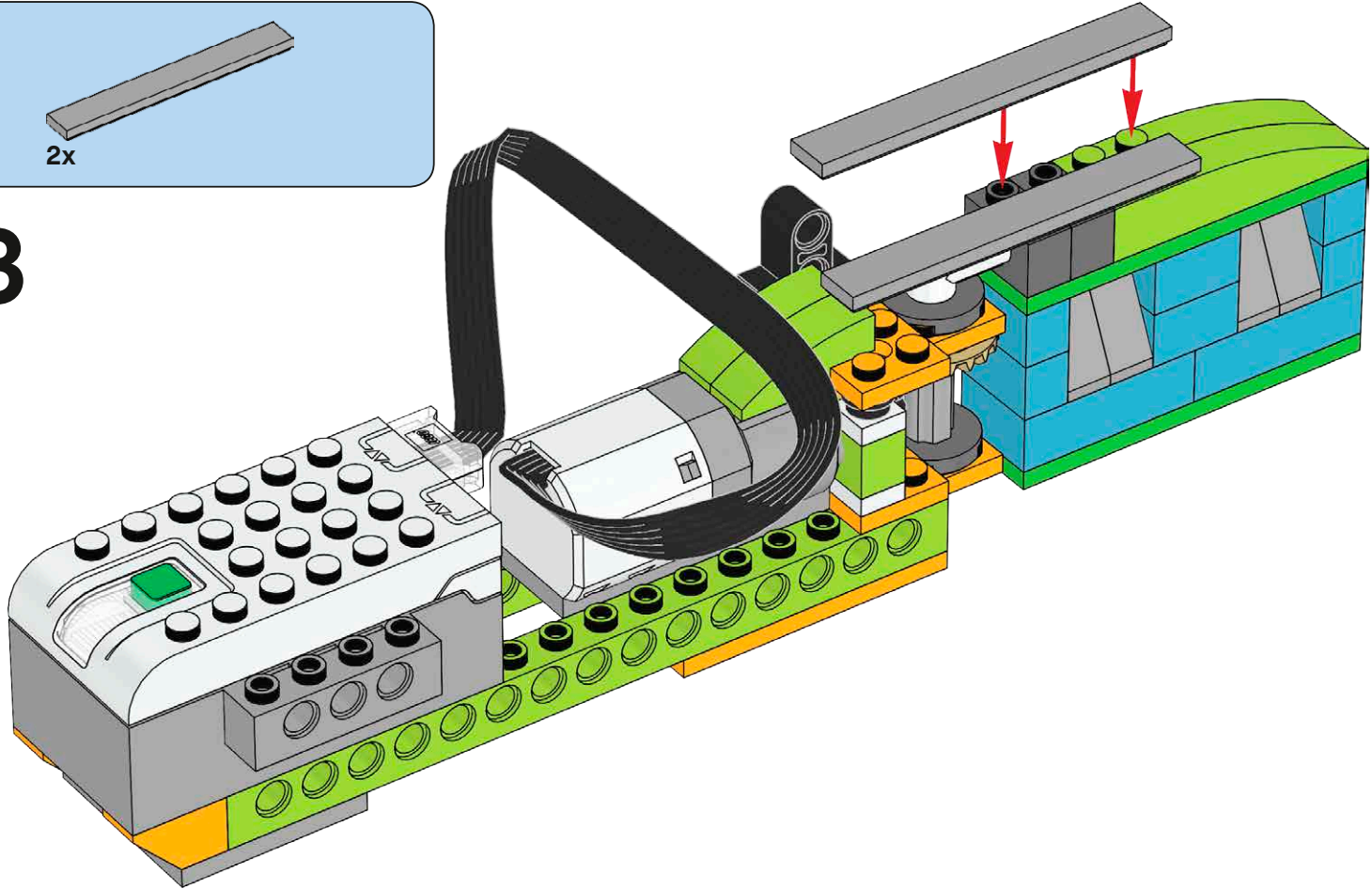

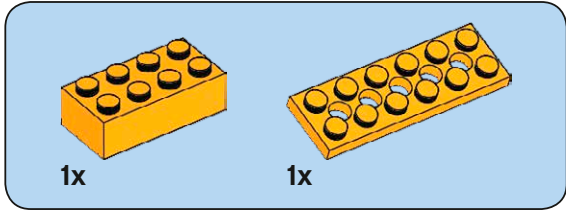

34

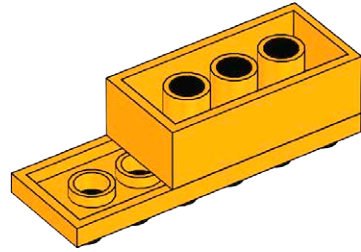

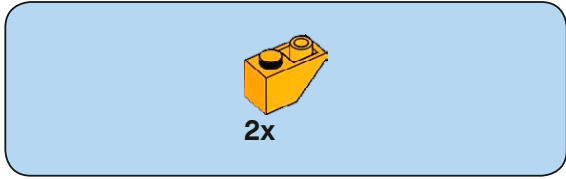

35

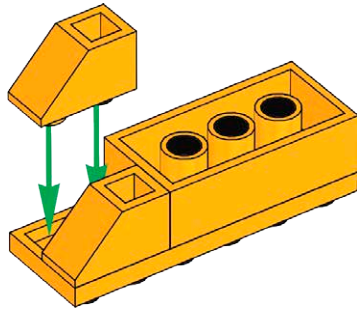

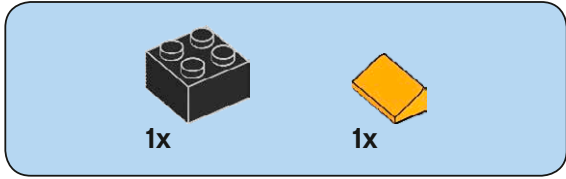

36

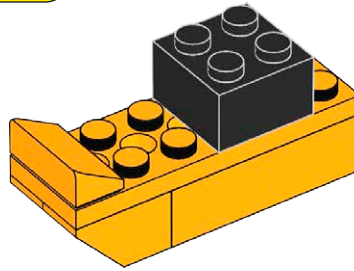
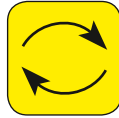

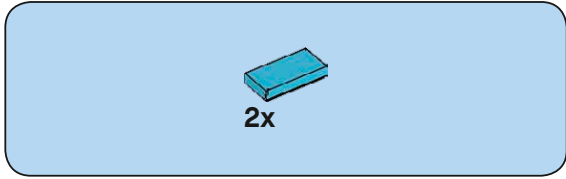

37

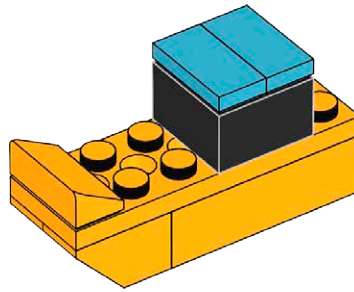

38

