

1

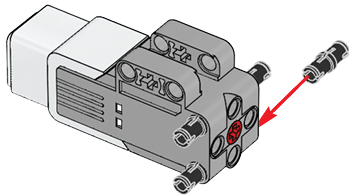

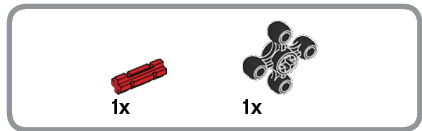

2

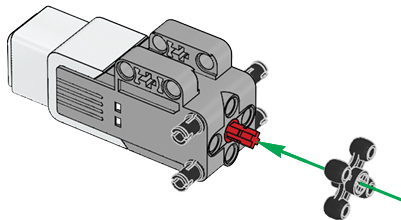

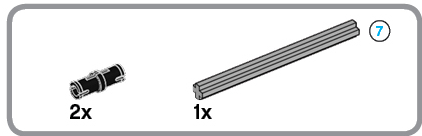

3

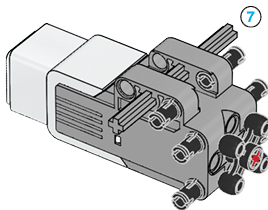

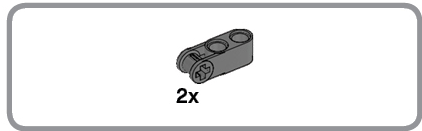

4

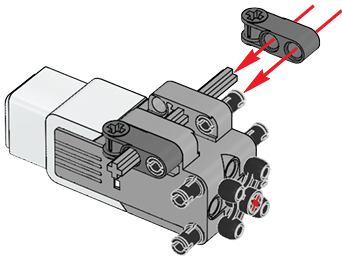

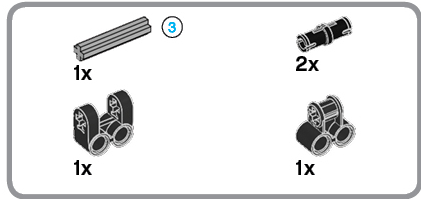

5

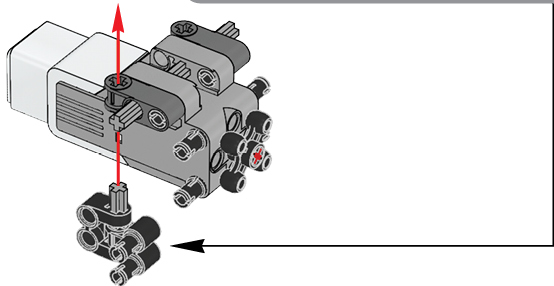
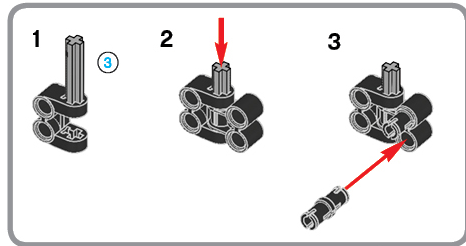



1x

6

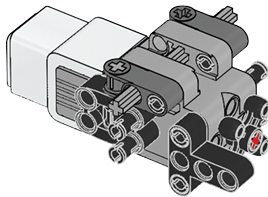

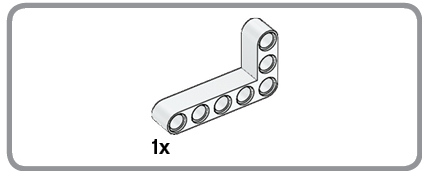

7

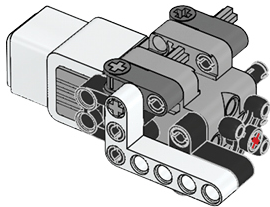

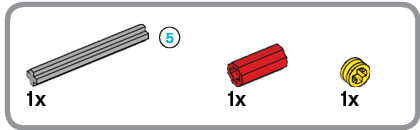

8

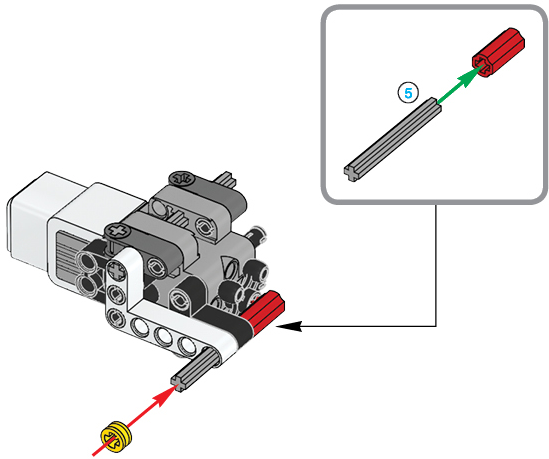

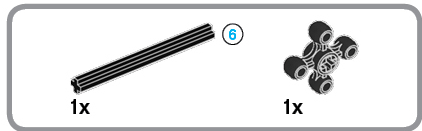

9

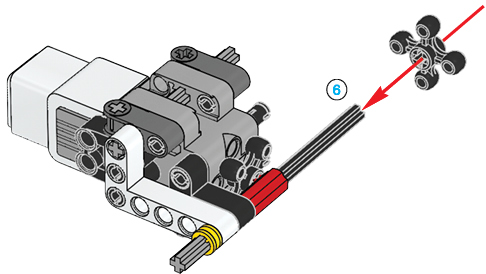

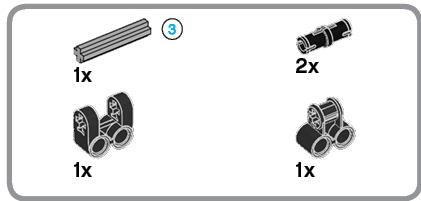

10

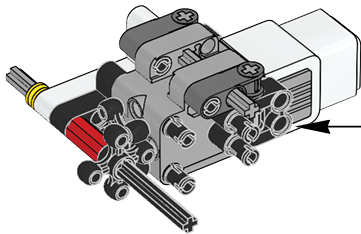
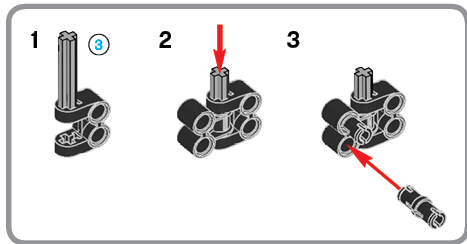



1x

11

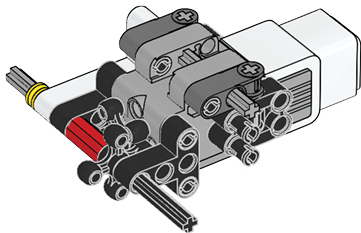

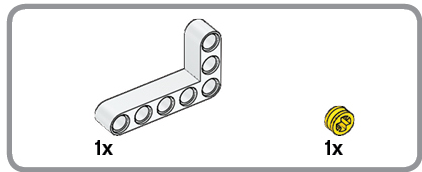

12

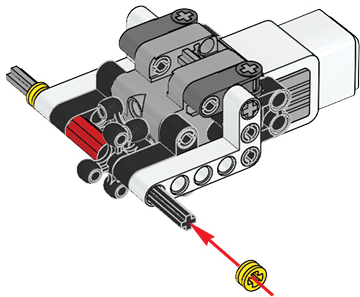

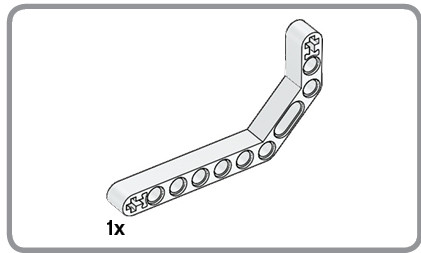

13

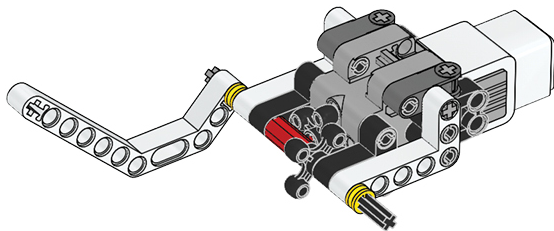

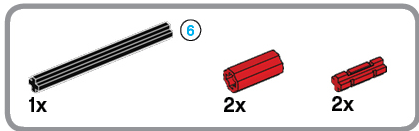

14

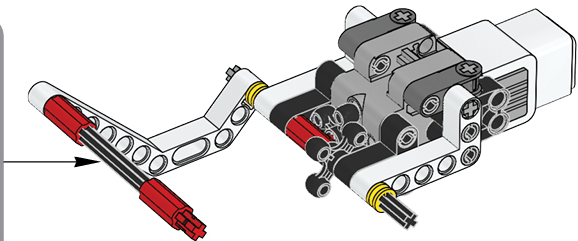
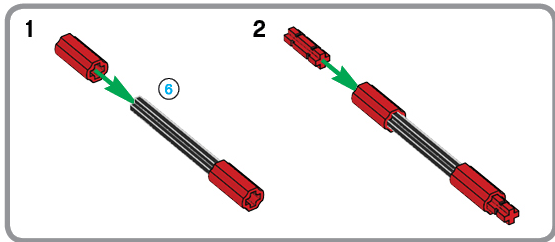

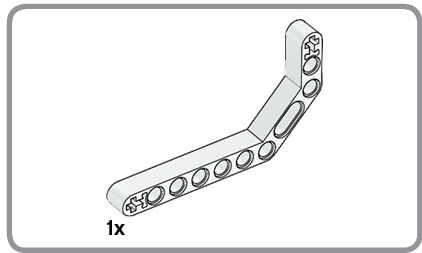

15

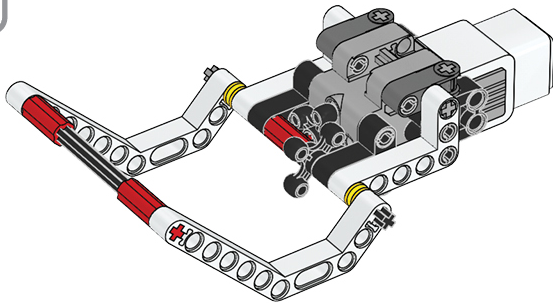

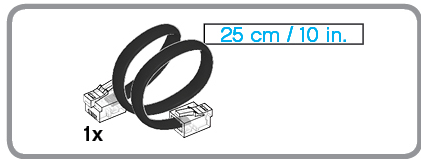

16

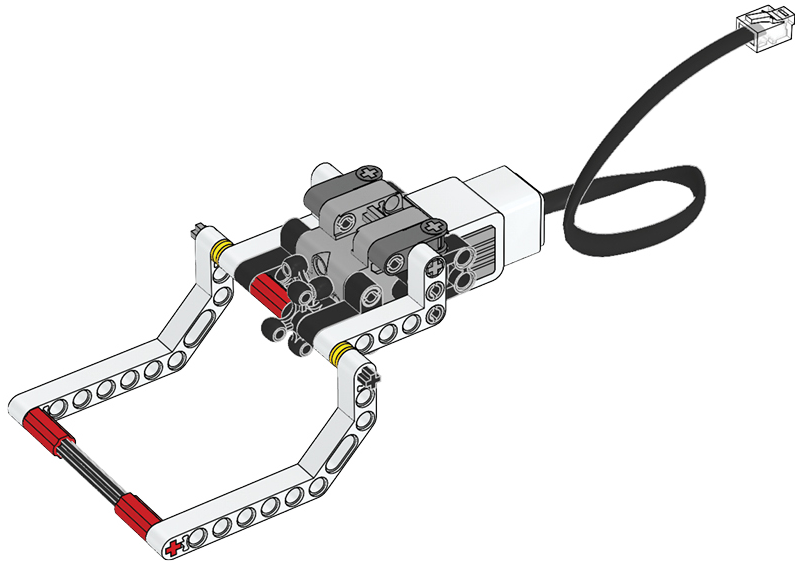

17

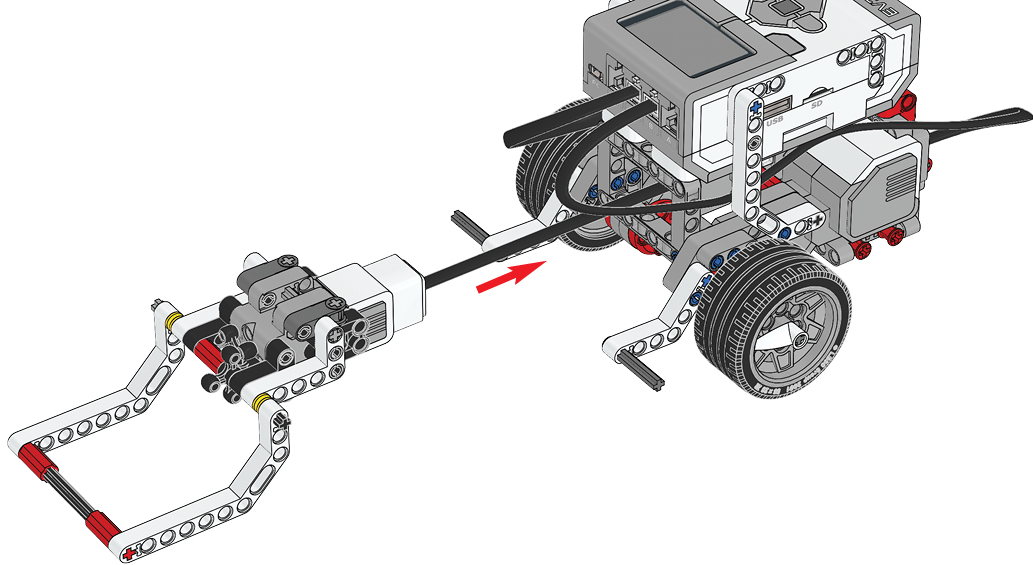

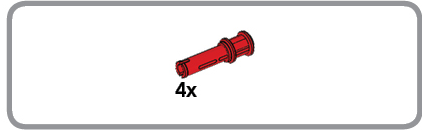

18

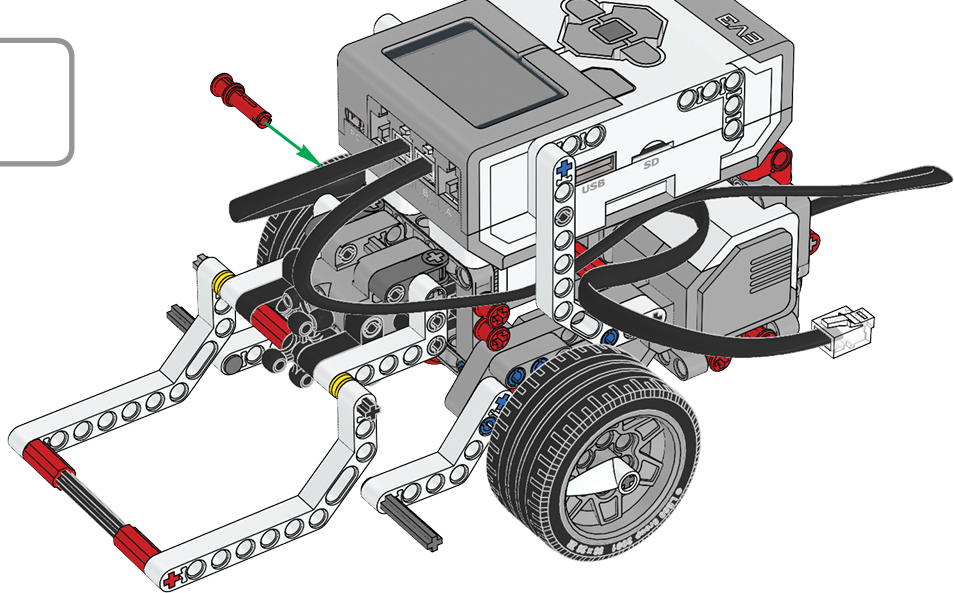

19

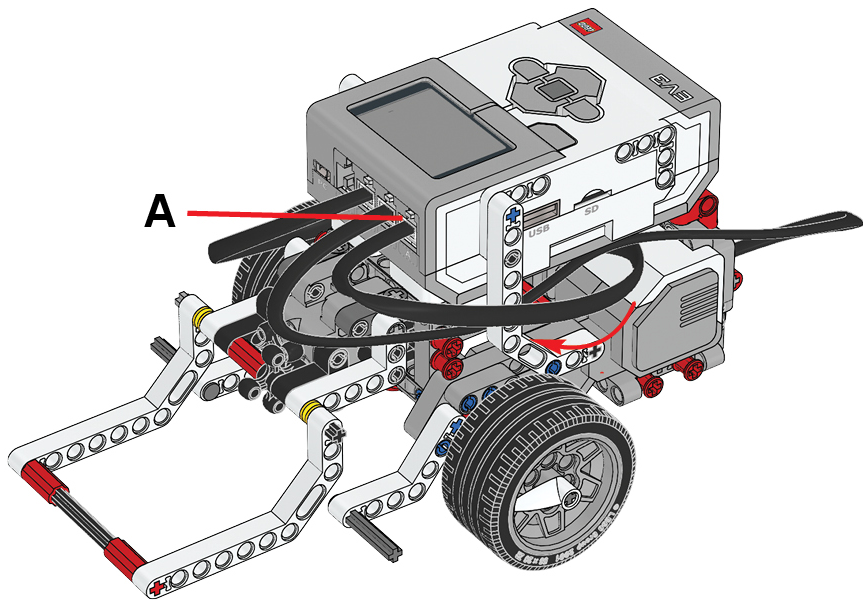

20

